

Donaldson.  
Torit®

**TORIT® POWERCORE®**  
**DUST COLLECTORS**  
**VL SERIES**



 PowerCore®

# SMARTER, SMALLER COLLECTORS

On every measurable scale, Torit® PowerCore® dust collectors outperform traditional baghouse and cartridge collectors. The new VL Series is smaller and much more cost-effective. And, from installation until the day it retires, it is so easy to use and maintain, you will never have to think twice about your Torit PowerCore dust collector.



(11,200 cfm collectors)  
Torit PowerCore VL 2-8  
vs. Traditional (144) 8-ft  
Filter Baghouse

## Lower Total Cost of Ownership

Fewer filters. Less downtime. Lower shipping costs. It all adds up to major cost savings over the life of the collector.

## Smaller Footprint

Up to 70% smaller footprint clears space for other equipment.

## Shorter

Lower clearance height fits in more low headroom applications and reduces transportation costs.

## Designed for Light and Fibrous Dust

Each PowerCore dust collector is built to the demanding standards you expect from Donaldson® Torit®. Its downward air pattern is designed to force light and fibrous dust directly into the hopper. This includes pulsed dust that can often get re-entrained on adjacent filters or can bridge between filters. In addition, a single inlet manifold reduces ducting and installation costs. And, of course, Donaldson Torit stands by the VL Series with strong technical support, 24-hour replacement filter shipping, and a 10-year warranty.

## Easy Filter Replacement

Changing filters requires no special tools or entering confined spaces, and downtime is held to a minimum.



## Fewer Filters

PowerCore filter packs save you money with every filter change.



One PowerCore filter pack replaces up to eighteen 8' bag filters or four cartridge filters.



# LIGHT AND FLUFFY DUST HAS MET ITS MATCH

The PowerCore VL Series brings the performance and simplicity of PowerCore technology to light and fibrous dust applications. Available for indoor and outdoor applications from 5,000 to 34,000 cfm, the VL Series is specially designed to handle light and fibrous dusts such as:



**Grain**  
**Fiberglass**  
**Diaper Fluff**  
**Plastic**

**Paper Trim**  
**Wood**  
**Rubber**  
**Insulation**  
**Textiles**



# THE NEW STANDARD IN DUST COLLECTION

It's not a cartridge. It's not a bag. PowerCore® filter packs take proprietary Ultra-Web® nanofiber filter media and form it into flutes that collect particles without depth-loading.

## Ultra-Web Media

PowerCore filter packs employ Donaldson® Torit's proprietary Ultra-Web nanofiber technology, and are backed by more than ten years of field tests.

Durable Ultra-Web nanofibers intercept even the smallest dust particles on the surface of the flutes. This surface-loading keeps the filter pack cleaner and improves the effectiveness of pulse cleaning, thus lowering both operational pressure drop and energy use.

## PowerCore Technology How It Works

Clean Ultra-Web Media

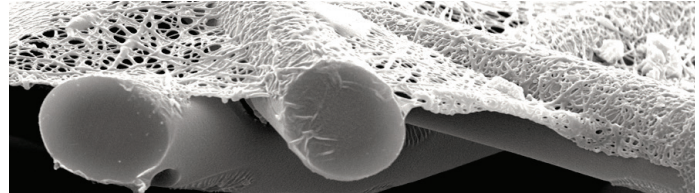

Surface-Loaded Ultra-Web Media (substrate still clean)

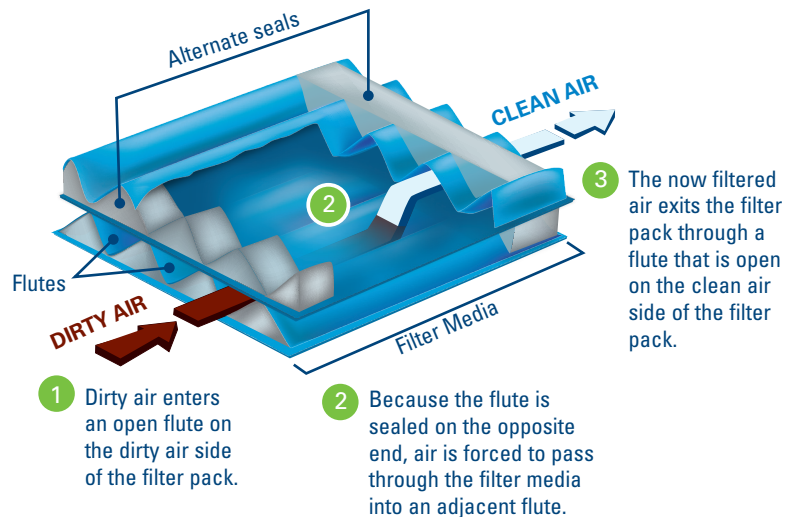
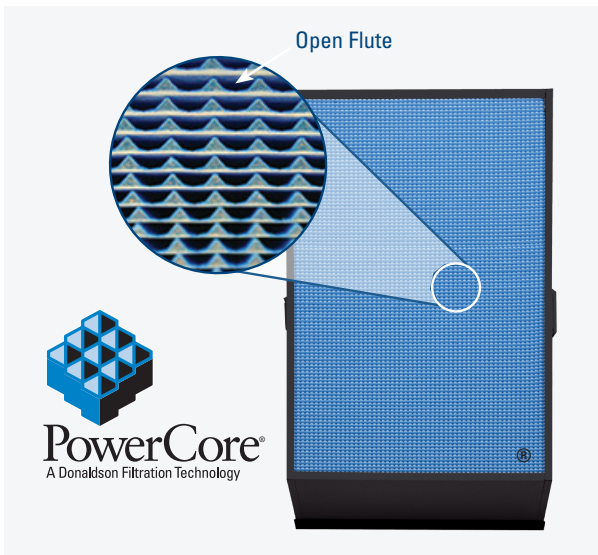
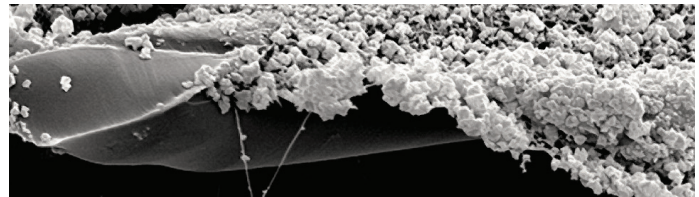

## Lower Emissions with PowerCore Filter Packs

The Torit PowerCore VL Series with PowerCore filter packs provides outstanding filtration efficiencies to help meet emission goals. PowerCore is rated MERV 15 and provides 78% fewer emissions than standard 16-ounce polyester bag filters.

**78%** FEWER EMISSIONS | MERV **15**

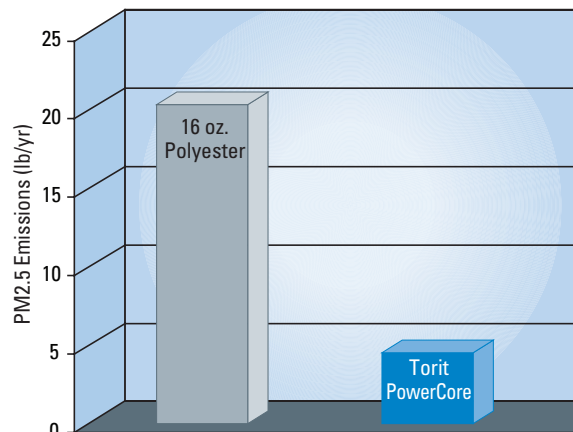

Independent lab results obtained using ASTM D6830-02 per EPA PM 2.5 performance verification.



# INSIDE THE POWERCORE VL

The PowerCore VL Series has a downward air pattern which is designed to handle the specific challenges of light and fibrous dusts. This downward air pattern pushes the newly introduced and pulsed dust, directly into the hopper to decrease the chances of bridging and dust re-entrainment.

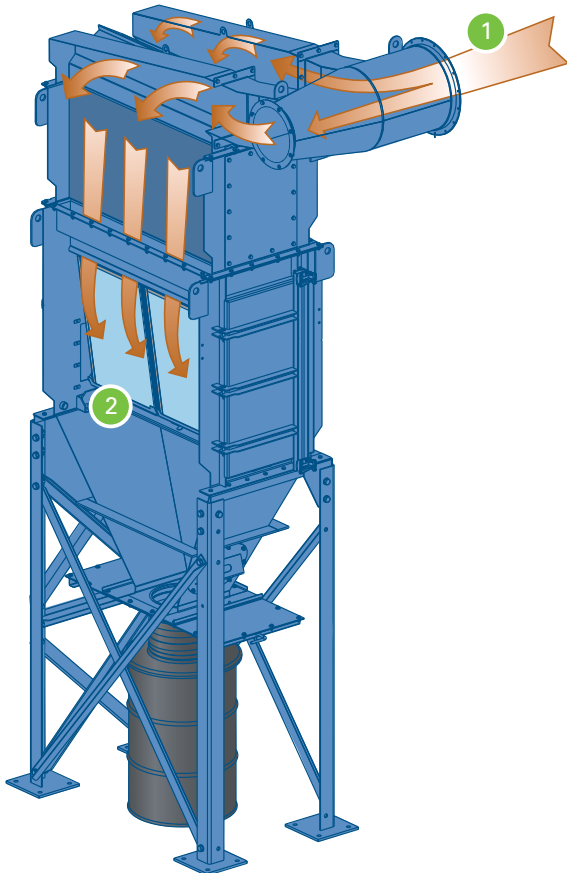

Standard Operation



Pulse Cleaning

## STANDARD OPERATION

- 1 Dirty air enters via the single inlet manifold
- 2 Dirty air flows downward through channels that forces dust directly into the hopper. Residual dust is filtered by the filter packs.
- 3 Clean air exits the collector
- 4 Compressed air ejects dust out of filter packs toward hopper
- 5 Downward air pattern pushes pulsed dust down to the hopper

## Zero-Turn Pulse Cleaning System

We call it Zero-Turn because the pulsed air is blown directly into the filters for maximum cleaning effectiveness. The V configuration of the PowerCore filter packs aligns the flutes in a near vertical formation allowing the dust to be pulsed directly into the hopper, preventing pulsed dust from being re-entrained on adjacent filter packs. Other collectors don't feature this directional alignment.

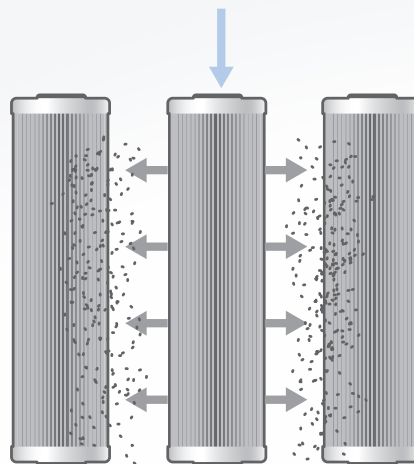

**Other Collectors**  
Pulsed dust blows from filter to filter.

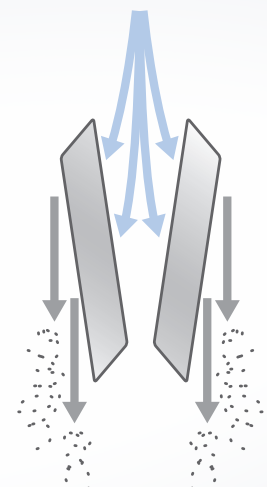

**PowerCore Collectors**  
Pulsed dust is shot directly into the hopper.

# QUICK CHANGE

Changing Torit PowerCore filter packs couldn't be easier. It's a one-person job and in a few minutes your operation is back up and running. A cartridge collector can't beat that. And a baghouse? Forget about it.

## Labor Savings at Filter Changeout

	Numbers of Filters	Time to Replace (hrs)	Labor Rate (per/hr)	Labor Cost	Savings in Hours*	Labor Savings*
PowerCore VL Filter Packs	8	0.5	\$45	\$23	23.5	\$1,057
Traditional Bag Filters	144	24.0	\$45	\$1,080		
PowerCore VL Filter Packs	16	1.0	\$45	\$45	3.0	\$135
Traditional Cartridge Filters	64	4.0	\$45	\$180		

\* Savings are based on one changeout. Calculations assume bags, cartridges, and PowerCore filter packs show equal life span; one person replacing one traditional bag filter in 10 minutes; one person changing PowerCore filter pack and cartridge in 3.75 minutes.



- 1 Open the quick-release door
- 2 Remove the first set of dirty filter packs
- 3 Slide out the tray and remove the second set of dirty filter packs
- 4 Insert new PowerCore filter packs and reverse the process

\* No special tools are required, and you never have to enter a confined space or dirty air manifold to do the job.

### Considering a Baghouse? Think Again.

If you really want one, Donaldson Torit offers the best in the business. But the fact is, the industry has evolved. PowerCore is the leading dust collector technology available today.



# GAINS VALUE AS IT AGES

PowerCore VL Series dust collectors are a smart decision that looks even better over time. That's because it is an investment that keeps paying off the longer you use it. You save money on installation. You save money on filter changeouts. And its improved performance allows you to run your equipment with less downtime for improved productivity.



## Space Savings

Up to 70% smaller footprint frees up valuable floorspace.

## Fewer Filters to Change

75-94% fewer filters to change dramatically cuts filter changeout costs related to labor and downtime.

## Easier Changeouts

Side entry doors and no confined spaces make changing filter packs fast and easy.

## Lower Emissions

Up to 78% fewer emissions than baghouses with traditional 16 oz (453.6 g) polyester bag filters.

## Reduced Shipping Costs

Its smaller size reduces shipping, installation and accessory costs.

## Improved Paint Performance

New paint tested to withstand a 2,000-hour salt spray keeps your Torit PowerCore dust collector looking good for years to come.

## Reduced Maintenance

The patented downward air pattern means no dust bridging between filters.

# DIMENSIONS & SPECIFICATIONS

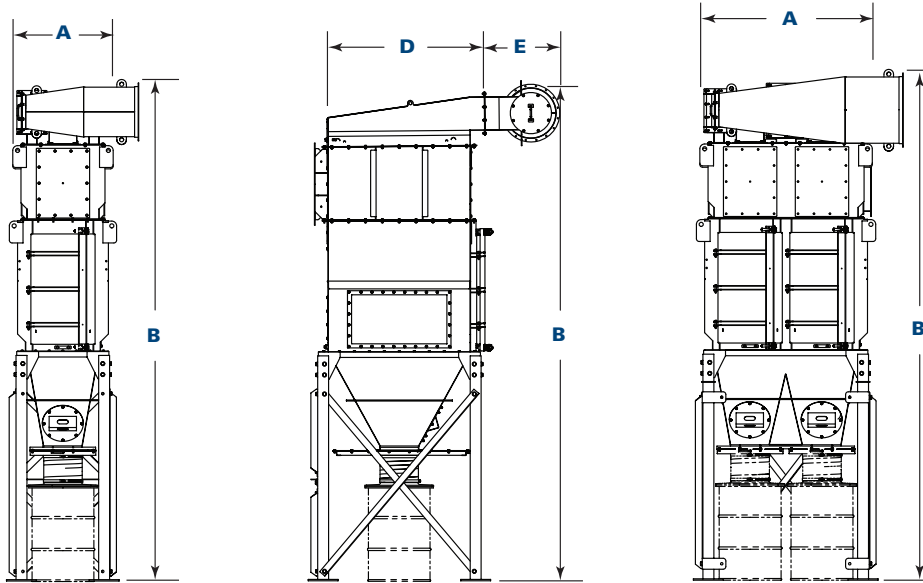

VL 1-4  
front view  
w/55 gal drum

VL 1-4  
left side view  
w/55 gal drum

VL 2-8  
front view  
w/55 gal drum

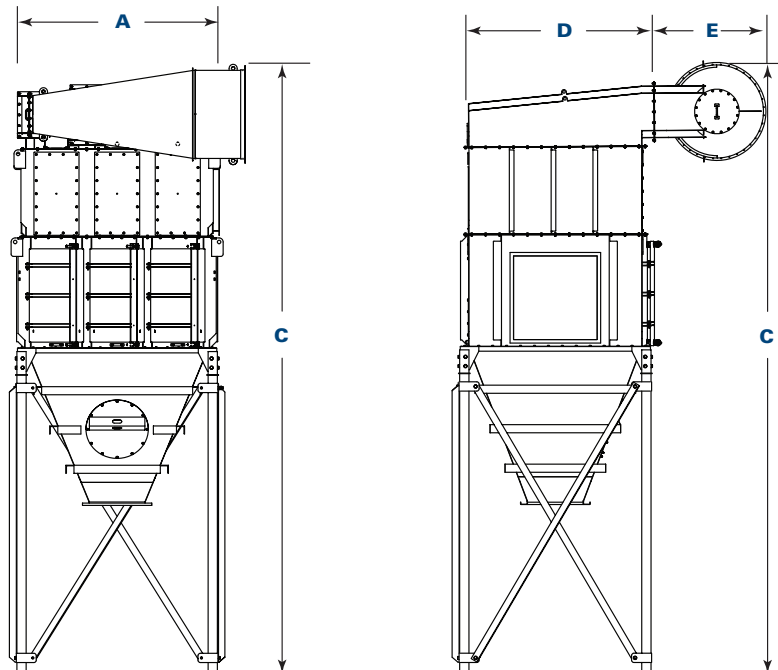

VL 3-18  
front view  
w/single outlet  
60° hopper

VL 3-18  
left side view  
w/single outlet  
60° hopper



# DIMENSIONS & SPECIFICATIONS

Model	Dimensions									
	A		B*		C**		D		E	
	in	mm	in	mm	in	mm	in	mm	in	mm
VL 1-4	36.8	933	183.6	4663	N/A	N/A	58.0	1473	30.7	780
VL 1-6	36.8	933	216.9	5509	N/A	N/A	78.9	2004	34.7	881
VL 2-8	63	1600	186.6	4740	210.6	5350	57.5	1461	36.7	932
VL 2-12	63	1600	221.9	5637	242.9	6170	80.1	2035	45.2	1148
VL 2-16	63	1600	N/A	N/A	273.4	6944	102.5	2604	49.2	1250
VL 3-18	89.3	2267	N/A	N/A	262.9	6677	80.1	2035	51.2	1300
VL 3-24	89.3	2267	N/A	N/A	288.3	7323	102.5	2604	55.2	1403

\* Height with 60° hopper for 55-Gallon (208.20-liter) drum.

\*\* Height with 60° rotary valve hopper with 72" clearance beneath hopper outlet flange.

Model	Nominal Airflow with High Body Inlet*		No. of Filter Packs	Power Core Filter Area		No. of Doors	No. of Valves	Shipping Weight**	
	cfm	m <sup>3</sup> /h		ft <sup>2</sup>	m <sup>2</sup>			lb	kg
VL 1-4	4,800-5,600	8,155-9,514	4	792	73.6	1	4	2,400	1,089
VL 1-6	7,200-8,400	12,233-14,272	6	1188	110.4	1	6	3,750	1,701
VL 2-8	9,600-11,200	16,310-19,029	8	1584	147.2	2	8	4,750	2,155
VL 2-12	14,400-16,800	24,466-28,543	12	2376	220.7	2	12	6,570	2,980
VL 2-16	19,200-22,400	32,621-38,058	16	3168	294.3	2	16	8,890	4,032
VL 3-18	21,600-25,200	36,698-42,815	18	3564	331.1	3	18	10,275	4,661
VL 3-24	28,800-33,600	48,931-57,086	24	4752	441.5	3	24	12,960	5,879

\* Based on clean filters.

\*\* Shipping weight is for units with single hopper (approximate).

## Operating Conditions for VL Collectors

Seismic Spectral Acceleration	$S_s = 1.5 g$ $S_1 = 0.6 g$ per IBC 2009 FIG 1613.5
Basic Wind Speed and Exposure (mph/kph)	90/145 Exposure C per IBC 2009
Housing Rating (inches of H <sub>2</sub> O/millimeters of H <sub>2</sub> O)	-20 / -508 (+10 / +254 option)
Compressed Air Required (psi/bar)	90-100/6.2-6.9
Operating Temperature	120°F/49°C
Housing Construction	3/16" (4.8mm) - 10-gauge steel
Control Voltage	120 VAC -or- 24 VDC

# VL SERIES APPLICATIONS



**POWERCORE® VL 2-12**  
**on Super Absorbent Polymer**  
14,500 cfm (24,630 m<sup>3</sup>/h)



**POWERCORE® VL 2-8**  
**on Paper Pleating Process**  
10,000 cfm (16,987 m<sup>3</sup>/h)



**POWERCORE® VL 2-12**  
**on Grain Dump**  
14,700 cfm (24,970 m<sup>3</sup>/h)



**POWERCORE® VL 2-8**  
**on Wood Dust**  
10,000 cfm (16,987 m<sup>3</sup>/h)



# STANDARD FEATURES & AVAILABLE OPTIONS

Collector Design	Std	Opt	Hopper Discharge	Std	Opt
Robust, Welded Mild Steel Construction	X		Slide Gate Packs		X
Clean-Side, Tool-Free Filter Pack Removal	X		55-Gallon (208.2-Liter) Drum Covers		X
Quick Release Filter Tray Levers	X		Rotary Valves and Transitions		X
Single Inlet Manifold	X		Heavy Duty Dumpster Discharge		X
ZERO-Turn Pulse Cleaning System	X		Live Bottom Hopper		X
Diaphragm/Solenoid Valve and Manifold Combination	X		<b>Support Structure †</b>		
Cleaning System Weather Cover	X		48" (1219 mm) Clearance Beneath Hopper for 55-Gallon (208.2-Liter) Drum	X	
Mountable Fan Package		X	72" (1575 mm) Clearance Beneath Hopper for Rotary Valves	X	
Filter Access Platform		X	62" (1575 mm) Clearance Beneath Hopper for Dumpster Discharge		X
Single Outlet Manifold		X	Leg Extensions		X
<b>Filter Packs</b>			<b>Electrical Controls, Gauges and Enclosures</b>		
PowerCore Ultra-Web® (MERV* 15)	X		Delta P Control NEMA Type 4 with Timer	X	
PowerCore Ultra-Web FR (Flame Retardant) (MERV* 15)		X	Delta P Plus Control NEMA Type 4 with Timer		X
PowerCore Ultra-Web AS (Anti-Static) (MERV* 15)		X	Pre-wired Junction Box to Solenoid Valves		X
PowerCore Ultra-Web SB (Spunbond) (MERV* 15)		X	110 VAC Control Voltage	X	
<b>Paint System</b>			24 VDC Control Voltage		X
Textured Multi-Coat Paint Finish with 2,000-Hour Salt Spray Performance	X		Heavy Duty Cold Climate Kit		X
Premium Duty Finish		X	Custom Control Panels		X
Custom Colors, Materials and Finishes		X	<b>Safety Features</b>		
<b>Hopper Design</b>			Sprinkler Couplings	X	
60° Pyramid Hopper	X		Explosion Vents		X
60° Live Bottom Hopper		X	<b>Warranty</b>		
Hopper Access Panel	X		10-Year Warranty	X	
Hopper Access Panel with Overflow Valve		X			

\* The Minimum Efficiency Reporting Value (MERV) of this filter cartridge has been determined through independent laboratory testing using ASHRAE 52.2 (2007) test standards. The MERV rating was determined at a face velocity of 118 feet (36.0 meters) per minute and loading up to four inches (101.6 mm) water gauge. Actual efficiency of any filter cartridge will vary according to the specific application parameters. Dust concentration, airflow, particle characteristics, and pulse cleaning methods all affect filtration efficiency.

\*\* Magnehelic and Photohelic are registered trademarks of Dwyer Instruments, Inc.

† Donaldson Torit equipment is designed to IBC guidelines for specific wind speed exposure and seismic spectral acceleration at grade level. Contact your Donaldson Torit representative for detailed information available on the equipment's Spec Control drawings. Equipment may be customized to meet unique, customer-specified site requirements.



## Global Support

- Facilities in 37 countries
- 40 manufacturing plants and 14 distribution centers

## Leading Technology

- Over 1,000 engineers and scientists worldwide
- Broad range of innovative collectors and filters
- 100s of filter media formulations

## Experience and Service

- Technical expertise and support
- Ready-to-ship filters and parts within 24 hours

Call Donaldson® Torit® to get cleaner air today:

**800-365-1331**

[Donaldson.com/ToritPowerCore](http://Donaldson.com/ToritPowerCore)



Tel 800-365-1331 (USA)  
Tel 800-343-3639 (within Mexico)  
[donaldsontorit@donaldson.com](mailto:donaldsontorit@donaldson.com)  
[donaldsontorit.com](http://donaldsontorit.com)

Donaldson Company, Inc.  
Torit  
P.O. Box 1299  
Minneapolis, MN  
55440-1299 U.S.A.

### **EXACTLY WHAT YOU NEED.™**

**Torit PowerCore Dust Collectors - VL Series (09/14)**  
© 2014 Donaldson Company, Inc. All Rights Reserved. All products, product specifications, and data (airflow, capacity, dimensions, or availability) are subject to change without notice, and may vary by region or country. Donaldson Torit, Torit PowerCore, Ultra-Web, and the color blue are registered trademarks of Donaldson Company, Inc. Contains Donaldson proprietary technology.